

ass-vz VESA adapter

Assembly instructions

The VESA adapter is compatible with the following products from Asus (asus.com):

V229, VX279, VZ239HE, VZ249HE, VZ279H, VZ279HE, VZ27AQ

The VESA adapter allows you to conveniently mount your ASUS brand monitor to a monitor arm with a VESA hole pattern (**75 x 75mm**). Use the included screws and nuts.

If you want to mount your VESA adapter directly to the wall, use suitable screws and dowels (**not included**).



Important Safeguards



Please read these instructions carefully and keep them for future reference. If you pass the product on to third parties, these instructions should always be included. Failure to follow these instructions may result in injury or damage to persons or the product, for which we cannot accept any liability.

IMPORTANT - KEEP FOR FUTURE REFERENCE.

- This product should always be used in accordance with the specified safety instructions.
- Do not install your VESA adapter in combination with the monitor in places where there are people below.
- Do not exceed the maximum weight of the compatible monitor models as this may result in serious injury or damage to property.
- Observe the maximum ambient temperature of 35°C when using the product.
- Do not mount the VESA adapter near a heat source or in direct sunlight, as this could heat up the adapter.
- Check whether your mounting point (e.g. monitor arm) can withstand the weight of the monitor with VESA adapter.
- The product is designed exclusively for mounting with a hole pattern of 75x75 mm.
- After installing the VESA adapter, the position of the monitor must be readjusted to ensure correct ergonomics.

CAUTION

Ensure that the device is switched off and disconnected from the power supply before installation to avoid possible injury or damage.

1. Before First Use

Check the product carefully for possible transport damage and for the absence of accessories, such as screws, which should be included in the scope of delivery.

CAUTION

Make sure that packaging materials and small screws and parts contained therein are inaccessible to children to minimize the risk of choking and other risks.

2. Maintenance and Cleaning

2.1 Maintenance

- It is recommended to check every three months that all screws are still tight. Also, regularly check the condition of all components of the product.
- Store the product in a cool and safe place, ideally at a maximum storage temperature of 40°C. For additional safety, keep the product away from children and preferably in its original packaging.
- Avoid any vibrations and shocks so as not to affect the life and functionality of the product.

2.2 Cleaning

- No corrosive or hot cleaning agents should be used to clean the product. Likewise, wire brushes, metal or other sharp materials are unsuitable for cleaning and should not be used.
- For gentle and effective cleaning, the use of a soft, damp cloth is recommended.

3. Waste Disposal

For the disposal of this product we recommend to contact the responsible local authorities or disposal services. They can provide you with detailed information on available disposal options and recycling centers in your area.

4. Manufacturer Information

3idee Technologies S.à r.l.
5 Um Lenster Bierg
L-6125 Junglinster
Luxembourg

5. Help and Feedback

If you need help with your article, we are here for you. We also appreciate any feedback.

<https://help.3idee.eu/en/contact>

Scope of Delivery Accessories

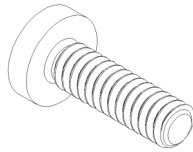

4x M4x14 screw with cross recess **1x** M6x20 screw with cross recess
(SP7) (SP7)

Horizontal / Vertical Alignment

Not all VESA adapters and monitors are suitable for vertical alignment. (upright)
This is due to the geometry of the adapter / monitor, which is sometimes not otherwise feasible.
We would like to point out that this information should not be disregarded under any circumstances, as the adapter will very quickly reach its durability limit if the mounting is not specified.

We always try to develop monitors for vertical (upright) mounting as well.

The standard orientation of a monitor is horizontal.

**Horizontal
Mounting: YES**



**Vertical
Mounting: NO**

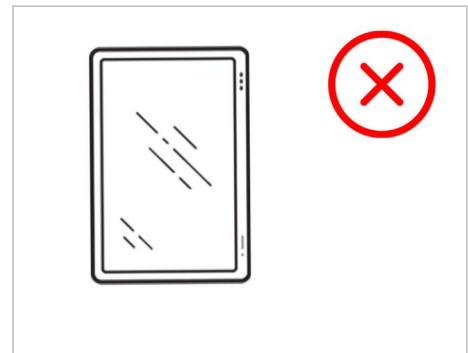

Assembly Instruction

Step 1

First, remove the base of your Asus monitor. To do so, loosen the screw underneath the monitor base. (Figure 1)

Please make sure you have a soft surface when storing the monitor for disassembly / assembly.

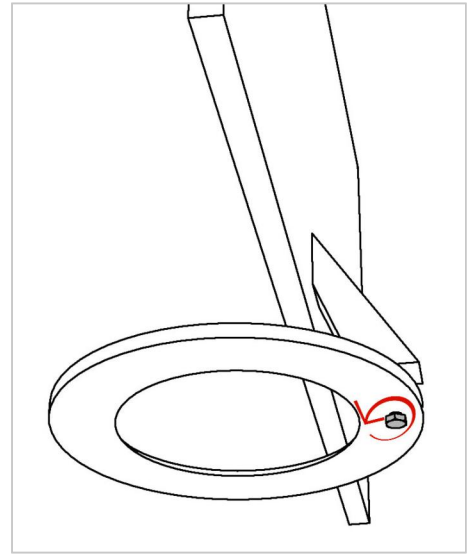

Figure 1

Step 2

Now attach the included plastic adapter to your monitor base from below as shown. (Figure 2)

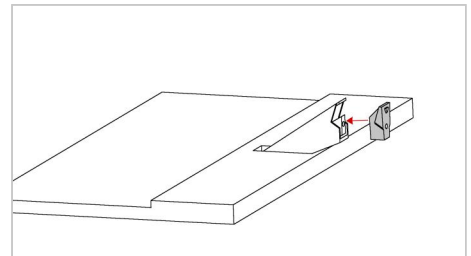

Figure 2

Step 3

This is how the attached plastic adapter should look now. (Figure 3)

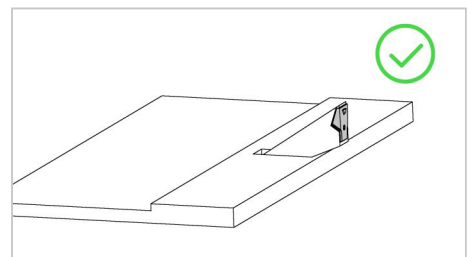

Figure 3

Step 4

Now please move the 3idee VESA adapter from below onto the monitor base / plastic adapter as shown. (Figure 4)

The triangle in the plastic adapter must fit into the triangle in the metal piece

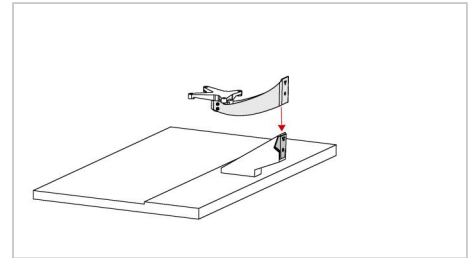

Figure 4

Step 5

The VESA adapter should now be in this position before we proceed to the next step. (Figure 5)

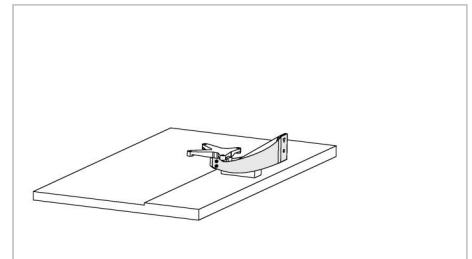

Figure 5

Step 6

Now screw the supplied screw from behind through the VESA adapter into the monitor base. (Figure 6)

Use a Phillips screwdriver for this.

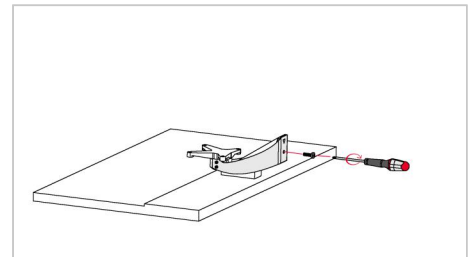

Figure 6

Step 7

Please check if the screw has been tightened properly. (Figure 7)

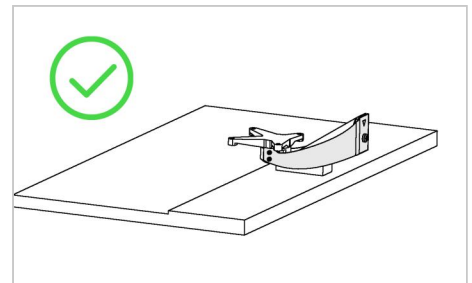

Figure 7

Step 8

⚠ **Important:** If the instructions in this step are not suitable for your device, please follow the mounting guidelines of the manufacturer of your monitor arm or swivel arm to mount the monitor to the wall or swivel arm.

We recommend a **second person** for this step.

Now lift the monitor and hold it against your monitor mount. Attach the VESA adapter using the 4 M4x14 screws supplied (**screw bag: SP2**).

It is best to fasten 2 screws diagonally first so that the monitor can no longer fall down and you can fasten the remaining screws easily.

ATTENTION: Make sure you use the right screws!

(Figure 8)

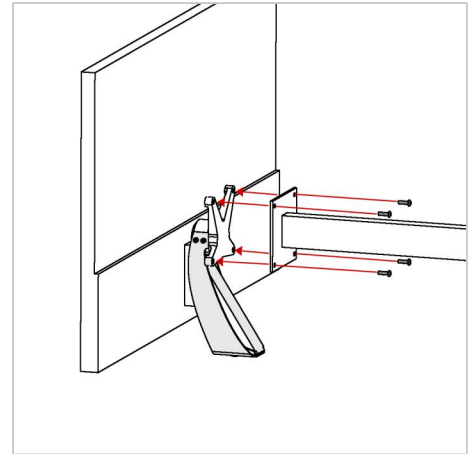

Figure 8

Step 9

Please make sure that all 4 screws are tightened firmly.

